

Article number: 03508100

Description: Fluro Rod end GE 100FW-2RS

Measures

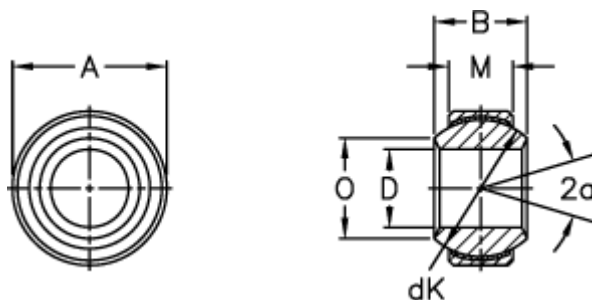

A = 160 0 -0,025

B = 85

D = 100 0 -0,020

dK = 140

Dynamic load C (kN) = 1230

M = 55

O = 111.2

Static load C0 (kN) = 2460

Tilt angle = 14

Weight = 6000